

SSMA Connectors



CHARACTERISTICS

Requirements	Specifications
General	
Material	Steel corrosion resistant per ASTM A-582, 300 Series, AMS 5567, AMS 5370 Brass Alloy per ASTM B-16 Beryllium copper per ASTM B-196 or B-197 PTFE Fluorocarbon per ASTM D-1457 or D-1710 Silicone Rubber per ZZ-R-765, CLASS IIB. 50-60 Shore.
Finish	Center contacts shall be gold plated to a minimum thickness of .00005-inch in accordance with ASTM B-488, Type 2, code C over nickel underplate. All other metal parts shall be finished so as to provide a connector which meets the corrosion requirements of this table.
Design	The design shall be such that the outline dimensions in this catalog are met. In addition, the assembled connector shall meet the interface dimensions. Dimensions are reference only unless stated.
Electrical	
Insulation Resistance	The insulation resistance shall not be less than 10,000 megaohms.
Dielectric Withstanding Voltage	Refer to applicable military slash sheet or consult factory.
RF High Potential Withstanding Voltage	Refer to applicable military slash sheet or consult factory.
Contact Resistance	Refer to applicable military slash sheet or consult factory.
Voltage Standing Wave Ratio (VSWR)	Refer to applicable military slash sheet or consult factory.
RF Leakage	Refer to applicable military slash sheet or consult factory.
Insertion Loss	Refer to applicable military slash sheet or consult factory.
corona Level	Refer to applicable military slash sheet or consult factory.
Mechanical	
Force to Engage and Disengage	The torque required to engage and disengage shall not exceed 2 inch-pounds. The longitudinal force is not applicable.
Coupling Nut Retention Force	60 lbs. minimum. Applicable to male connectors only.
Coupling Proof Torque	15 in.-lbs. minimum. Applicable to male connectors only.
Cable Retention Force	Refer to applicable military slash sheet or consult factory.
Mating Characteristics	See interface dimensions shown. Applicable to females only; oversize pin .0213 .0001/-.0000 diameter .030/.045 deep: Insertion force 3 bls. maximum .0208 +.0001/-.0000 diameter pin: withdrawal force 1 oz. minimum with .0195 maximum diameter pin.
Connector Durability	The connector to be tested and its mating connector shall be subjected to 500 insertion and withdrawal cycles at 12 cycles per minute max. The connector shall show no evidence of mechanical failure and the connector shall meet the mating characteristic requirements.
Recommended Mating Torque	5 inch-pounds.
Environmental	
Vibration	Specification MIL-STD-202, Method 204, Test Condition D.
Shock	Specification MIL-STD-202, Method 213, Test Condition I.
Thermal Shock	Refer to applicable military slash sheet or consult factory.
Corrosion (Salt Spray)	Specification MIL-STD-202, Method 101, Test Condition B.
Moisture Resistance	Specification MIL-STD-202, Method 106. No measurement at high humidity. Insulation resistance shall be 200 megaohms min. within 5 minutes after removal from humidity.

The specifications below are general specifications for all SSMA connectors. Specific specifications for VSWR, insertion loss, and RF leakage for each connector is available from the factory upon request. Specifications in the following table are recommended for any procurement documents or drawings. In the event of any conflict between these specifications and General specification MIL-PRF-39012 and MIL-PRF-83517, these specifications shall govern. These specifications are subject to change according to the latest revision of General Specification MIL-PRF-39012 and MIL-PRF-83517.

SSMA Connectors

Interface Mating Dimensions (Per MIL-STD-348)

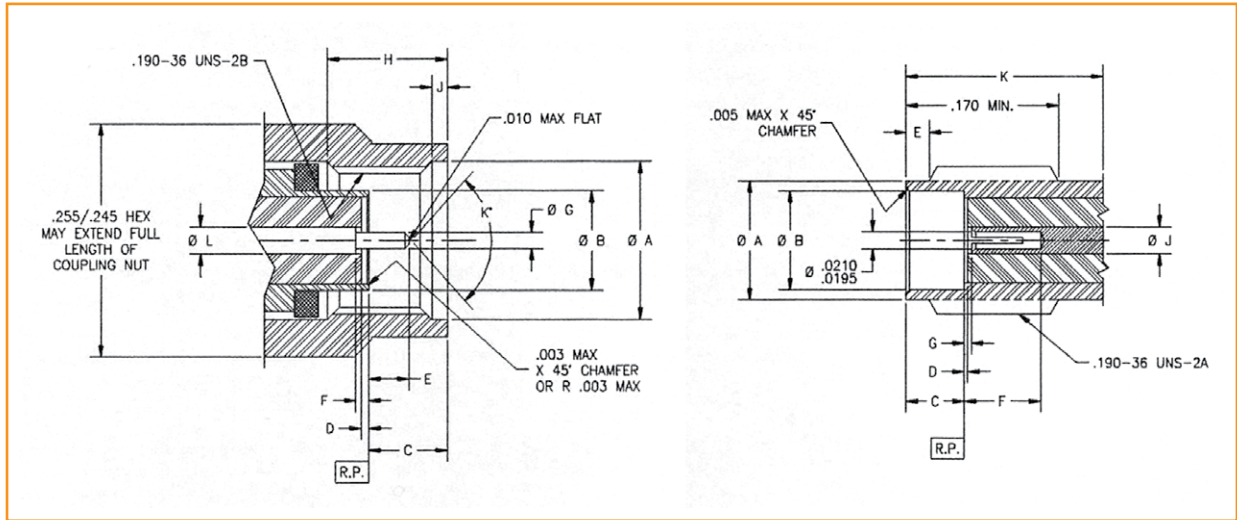

MALE

LTR	Minimum		Maximum	
	in	mm	in	mm
ØA	.196	4.98	.202	5.13
ØB	.1240	3.15	.1268	4.27
C	.100	2.54	.133	3.38
D	.000	0.00	.010	0.25
E	.050	1.27	.065	1.65
F	0.00	0.00	.010	0.25
ØG	.0195	0.05	.0208	0.53
H	.130	3.30	---	---
J	.015	0.28	.045	1.14
K°	70°	70°	90°	90°
L	.0335	0.85	.0348	0.88

FEMALE

LTR	Minimum		Maximum	
	in	mm	in	mm
ØA	.147	3.73	.150	3.81
ØB	.127	3.23	.130	3.30
C	.075	1.91	.077	1.96
ØD	.000	0.00	.010	0.25
E	.020	0.51	.040	1.02
F	.075	1.91	---	---
G	.000	0.00	.010	0.25
ØJ	.0335	0.85	.0348	0.88
K	.230	5.84	---	---

Note(s):

- Dimensions are inches.
- Metric equivalents (to the nearest 0.01mm) are given for general information only and are based on 1 inch = 25.4 millimeters.

Straight Plug for UT085

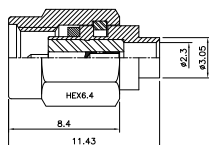

Part No.
SSMA-101-005

Straight Plug for RG316

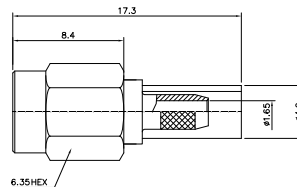

Part No.
SSMA-111-001

SSMA Connectors

Straight Jack for UT085

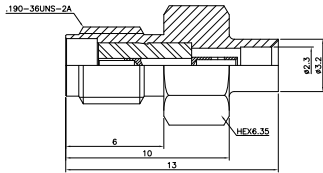

Part No.

SSMA-201-003

Right Angle Plug for UT085

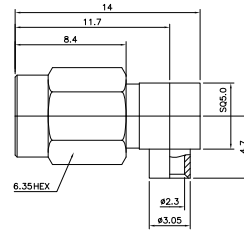

Part No.

SSMA-301-003

Bulkhead Jack for UT085

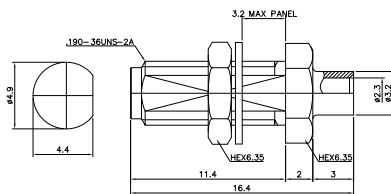

Part No.

SSMA-401-003

Bulkhead Jack for RG178

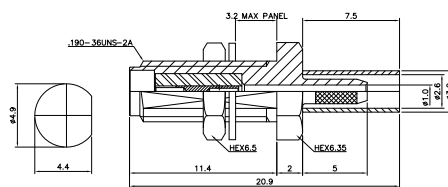

Part No.

SSMA-410-001

Panel Receptacle Jack-4Hole

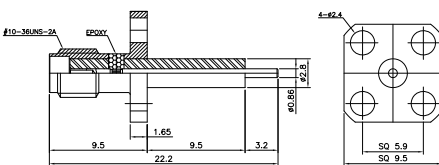

Part No.

SSMA-504-002

Bulkhead Receptacle Jack

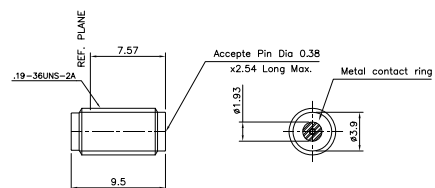

Part No.

SSMA-506-001

Straight PCB Jack

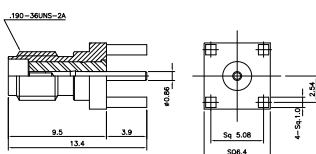

Part No.

SSMA-602-001

Dust Cap Plug

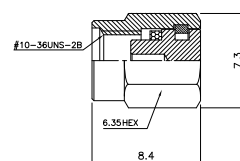

Part No.

SSMA-701-003

SSMA Connectors

Dust Cap Jack

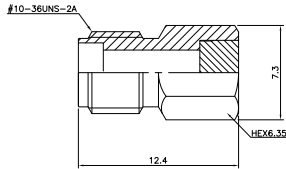

Part No.
SSMA-702-001

Jack to Jack Adapter

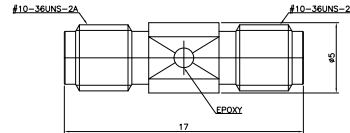

Part No.
SSMA-803-001

Bulkhead Jack to Jack Adapter

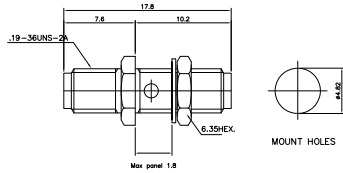

Part No.
SSMA-804-001

Jack to Jack Adapter-4Hole

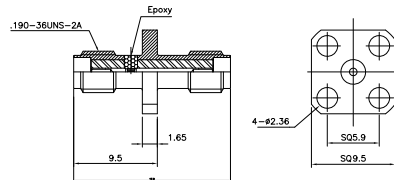

Part No.
SSMA-805-001

Jack to Jack Adaptor-2Hole

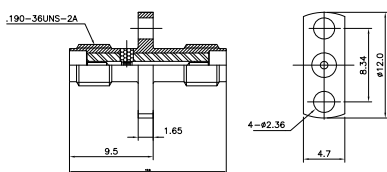

Part No.
SSMA-805-002

RA Plug to Jack Adapter

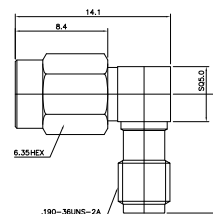

Part No.
SSMA-806-002

RA Jack to Jack Adapter

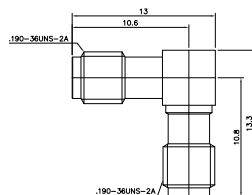

Part No.
SSMA-806-003

